

INSTALLATION INSTRUCTIONS

TROFFER RETROFIT SERIES UltraSelect® LED

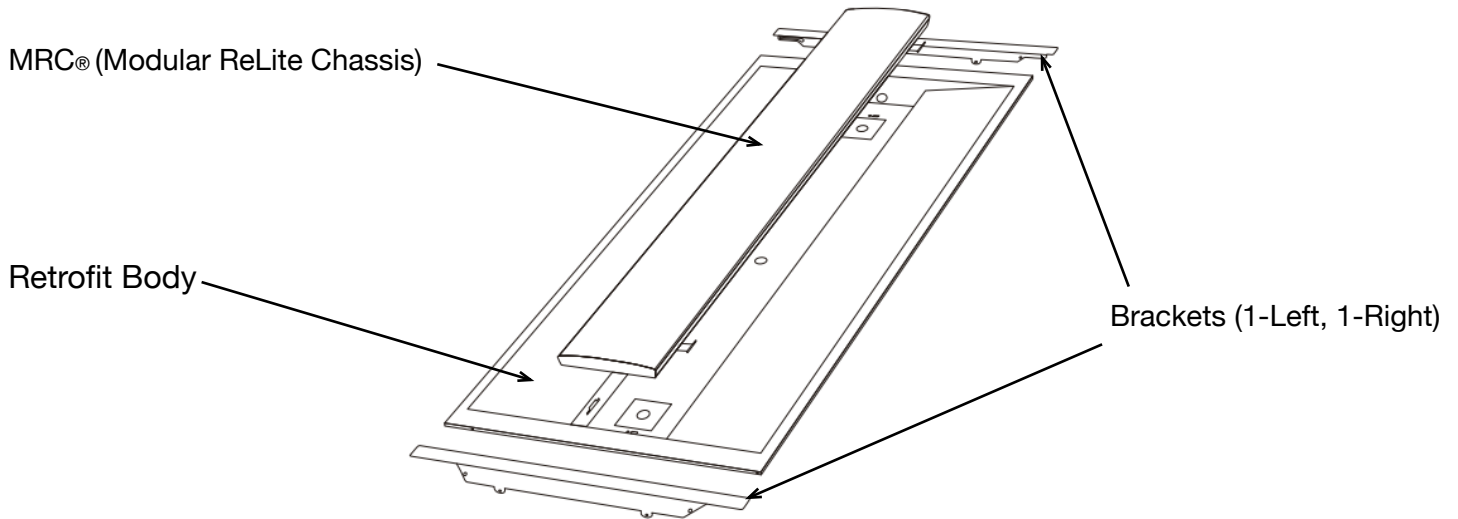

Part# TRS-MRC-24-US40-UNV-D

READ CAREFULLY BEFORE INSTALLATION.

PLEASE KEEP MANUAL FOR FUTURE USE.

Manuals and installation videos can also be found online at www.apprimelighting.com



WARNING

Risk of Fire or Electric Shock

Make sure power is off at the circuit breaker before installation.

To prevent wire damage or abrasion, do not expose wiring to edges of sheet metal or sharp objects.

Installation guide requires knowledge of luminaire electrical systems. If not qualified, do not attempt installation. Contact a qualified electrician.

Never perform maintenance or cleaning while troffer retrofit is energized. Disconnect power and allow troffer retrofit to cool before servicing.



MAINTENANCE CAUTION

Review the diagrams before beginning and make sure the troffer retrofit is grounded properly.

For lighting controls, use driver wiring diagram.

Maintenance must be done by qualified personnel.

Use a clean, dry cloth to clean the troffer retrofit.

For any questions regarding wiring, installation, or use of this troffer retrofit, please contact us: support@apprimelighting.com

INSTALLATION GUIDE

1. Turn off power before installation. See diagram 1.
2. Install both left and right side brackets to the existing fixture; use the provided self tapping screws to attach the brackets to the existing fixture housing. See diagram 2.
3. Securely hang the retrofit body by inserting the nodes located on each end of the retrofit body, into the slots located on both right and left brackets. With retrofit body now hanging securely, pull incoming line-voltage power through one of the five knockouts located at the ends or backside of the retrofit body. Then swing the retrofit body up into the existing fixture housing. Secure the other side of the retrofit body by locking the latches. See diagram 3.
4. Insert the hinges of the MRC® into the housing slots in the center of the retrofit body. Slots and hinges are universal allowing for MRC® to be inserted from either side. See diagram 4. Allow one side of the MRC® to hang securely through steps 5-6.
5. Attach the safety cables of the MRC® by hooking them onto the i-slots of the retrofit body. See diagram 5.
6. Make electrical connections to the MRC® in accordance with local electrical code. Make all necessary, wiring connections, observing proper voltage and polarity. **Use the provided luminaire quick disconnects to assure proper install, service or upgrade ability of the MRC.** See diagram 6.
7. Swing the MRC® up to the retrofit body, slide spring loaded latches into the slots of the retrofit body, locking it into place. Align length side of the lens into the outer edge groove of the MRC®, gently squeeze lens and attach the other side of the lens into the adjacent groove of the MRC®. See diagram 7.
8. Turn power on. See diagram 8.

UltraSelect® COLOR & LUMEN ADJUSTMENTS

- A. The TRS comes equipped with UltraSelect® advanced technology, allowing 4 customizable color temperatures and 4 lumen (wattage) outputs. The factory settings are preset to 40W and 4000K.
- B. Slide the toggle switches, located on the backside of the MRC® to make your UltraSelect® adjustments.
- C. Toggle switch indicator decal located beside UltraSelect® adjustment module.

